

Regency Railings

Geno

SCALE: 3/4"=1'-0"

U.S. PATENT #5,820,111
U.S. PATENT #6,059,269

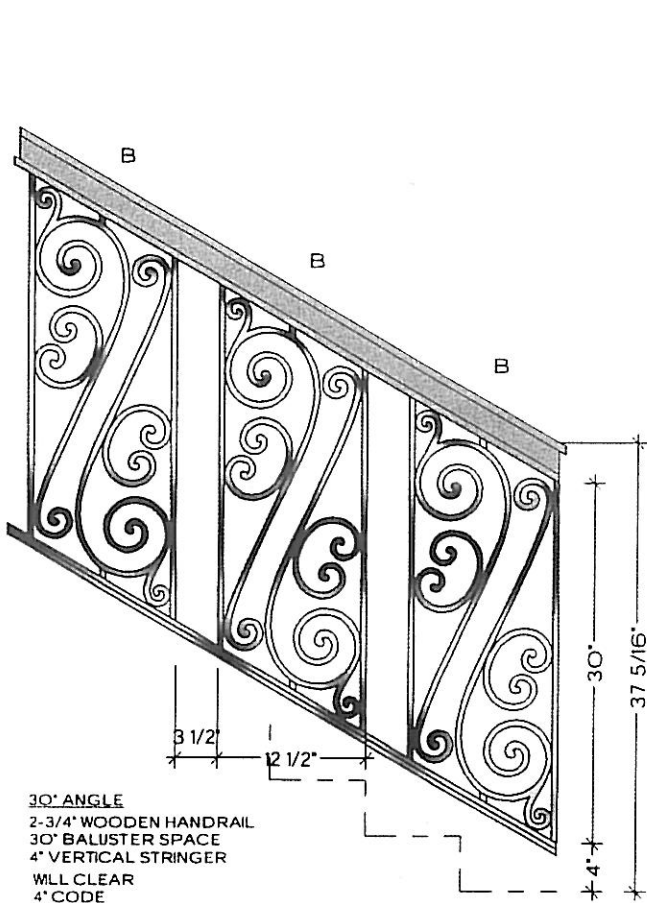

30° ANGLE
2-3/4" WOODEN HANDRAIL
30" BALUSTER SPACE
4" VERTICAL STRINGER
WLL CLEAR
4" CODE

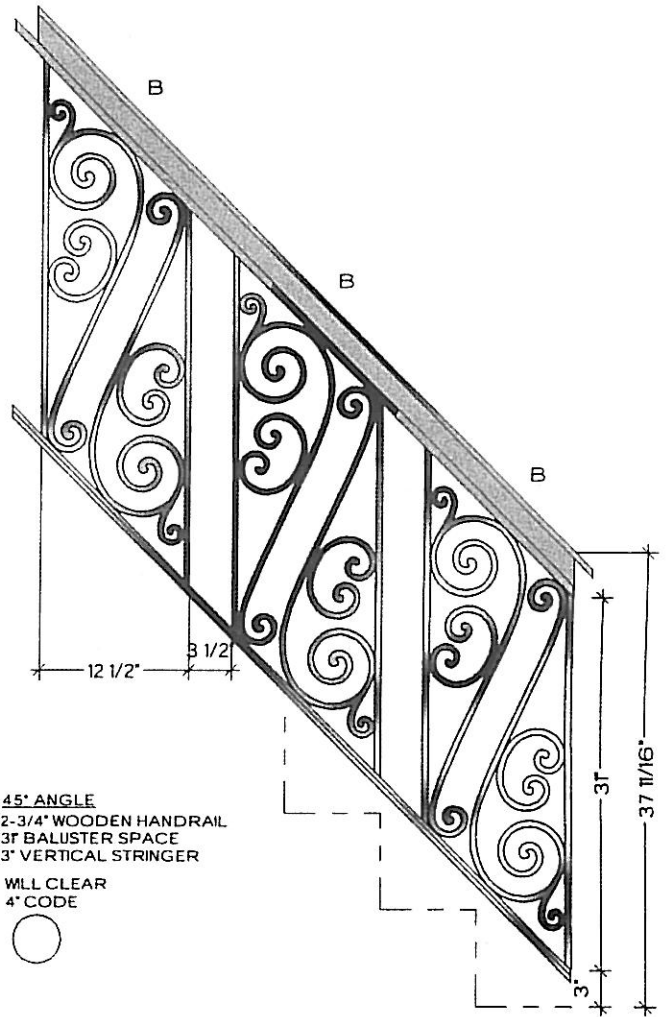

45° ANGLE
2-3/4" WOODEN HANDRAIL
31" BALUSTER SPACE
3" VERTICAL STRINGER
WLL CLEAR
4" CODE

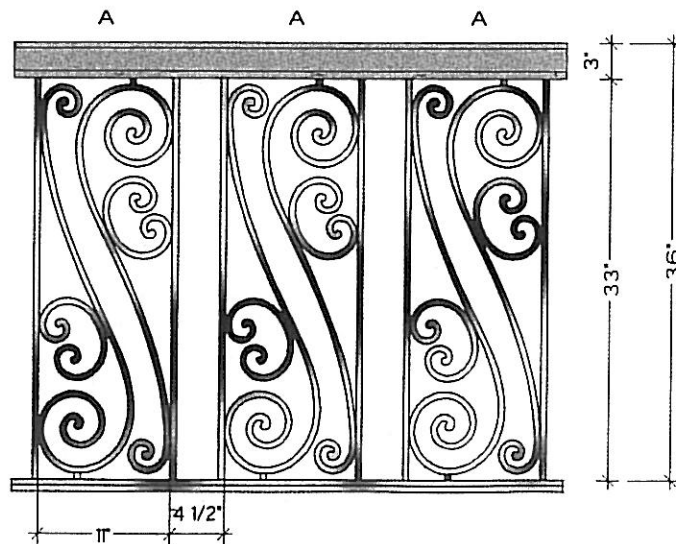

BALCONY
3" WOODEN HANDRAIL
33" BALUSTER SPACE

WLL CLEAR
4" CODE



Regency Railings

Geno

SCALE 1/2"=1'-0"

U.S. PATENT #5,820,111
U.S. PATENT #6,059,269

PIECE A
FITS LEVEL BALCONY
OR STRAIGHT RAILS

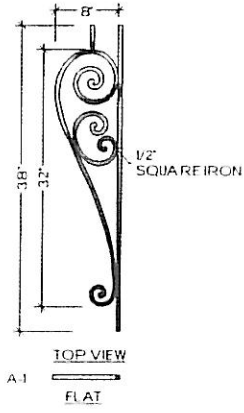

PIECE A
FITS LEVEL BALCONY
OR STRAIGHT RAILS

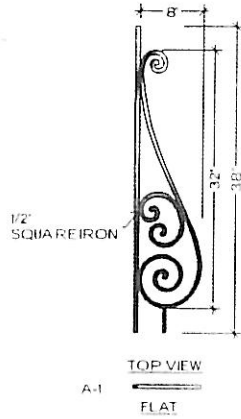

PIECE B
FITS ANGLES UP TO 48°

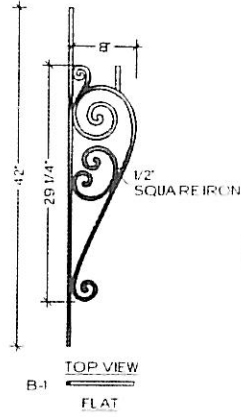

PIECE B
FITS ANGLES UP TO 48°

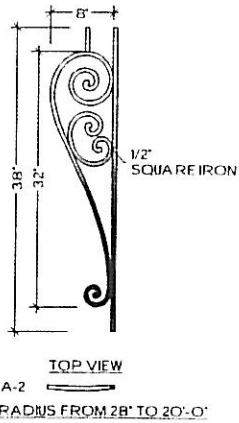
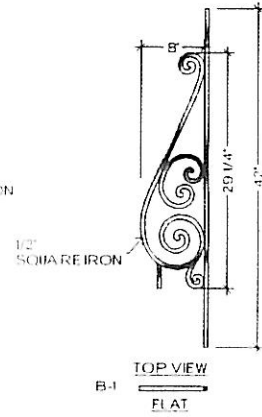

ALL RADIUS FROM 28" TO 20'-0"

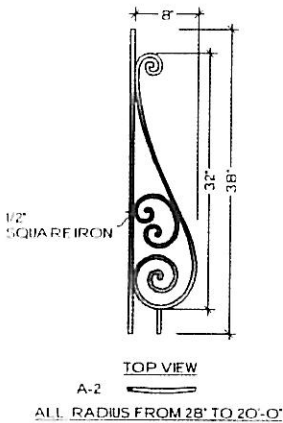

ALL RADIUS FROM 28" TO 20'-0"

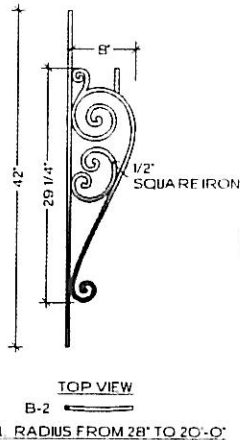

ALL RADIUS FROM 28" TO 20'-0"

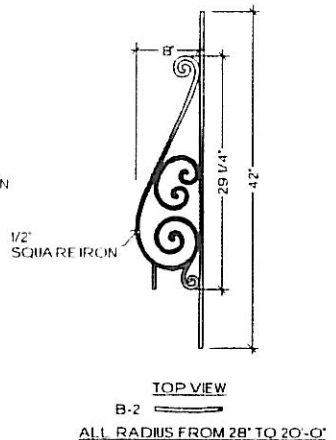

ALL RADIUS FROM 28" TO 20'-0"

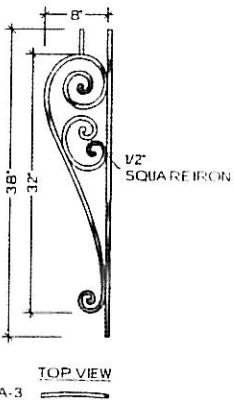

ALL RADIUS FROM 28" TO 20'-0"

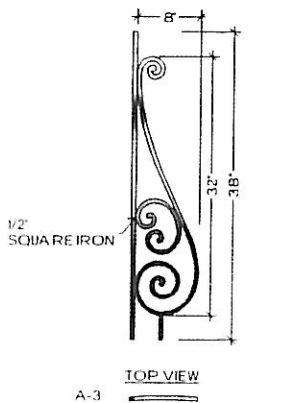

ALL RADIUS FROM 28" TO 20'-0"

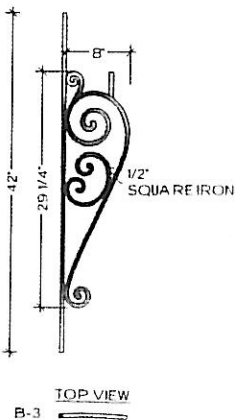

ALL RADIUS FROM 28" TO 20'-0"

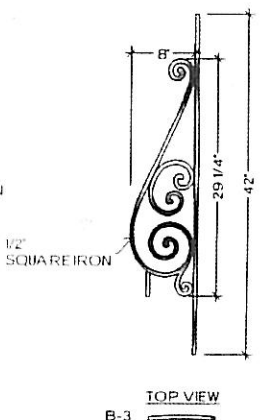

ALL RADIUS FROM 28" TO 20'-0"